



Primelite Manufacturing Corp.

407 S Main St, Freeport, NY 11520
 Phone: (516) 868-4411 | Fax: (516) 868-4609
 sales@primelite-mfg.com | www.primelite-mfg.com

PROUDLY MADE IN THE USA SINCE 1962!
"SPECIALTIES ARE OUR SPECIALTY!"

Job Info

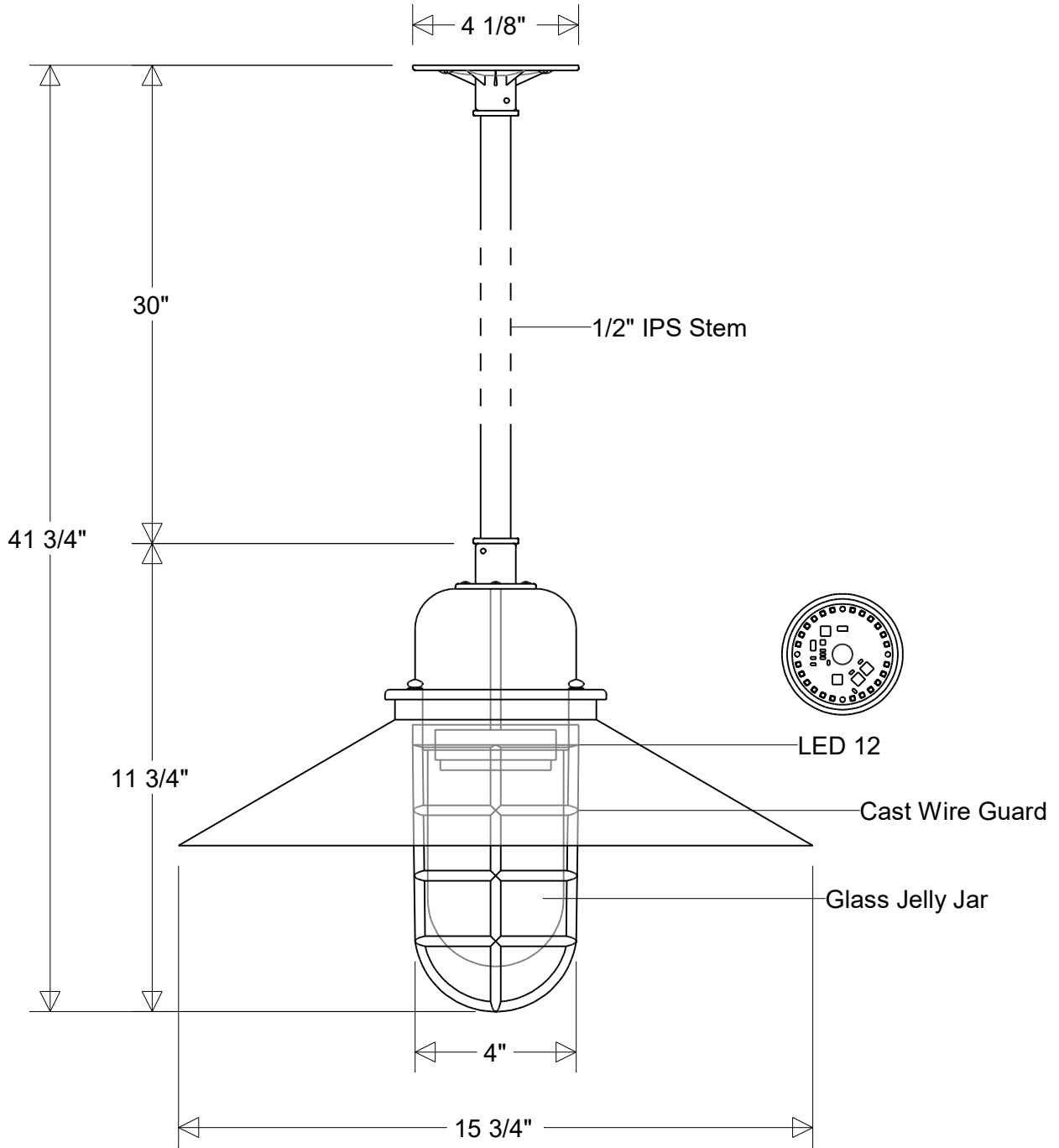

#423/16-*-WG-18-30 LED 12

15 3/4" Dia | 41 3/4" H | 30" X 1/2" IPS Stem
 Jelly Jar: Clear (*4) | Prismatic (*4P) | Frost (*5)

Lamp: 12 W LED
 CCT: 3K or 4K
 75W Inc Equivalent
 80 CRI
 120V
 Electronic Dimming

Finish:
 29 Oven Baked
 Powder Coated Paints
Material:
 Aluminum
 Glass Jelly Jar

Drawn:
 CB
 06/2026
Note:
 All dimensions are nominal.
 Actual dimensions may vary.

Scale:
 1/4

Approvals