



Primelite Manufacturing Corp.

407 S Main St, Freeport, NY 11520
 Phone: (516) 868-4411 | Fax: (516) 868-4609
 sales@primelite-mfg.com | www.primelite-mfg.com

PROUDLY MADE IN THE USA SINCE 1962!
"SPECIALTIES ARE OUR SPECIALTY!"

Job Info

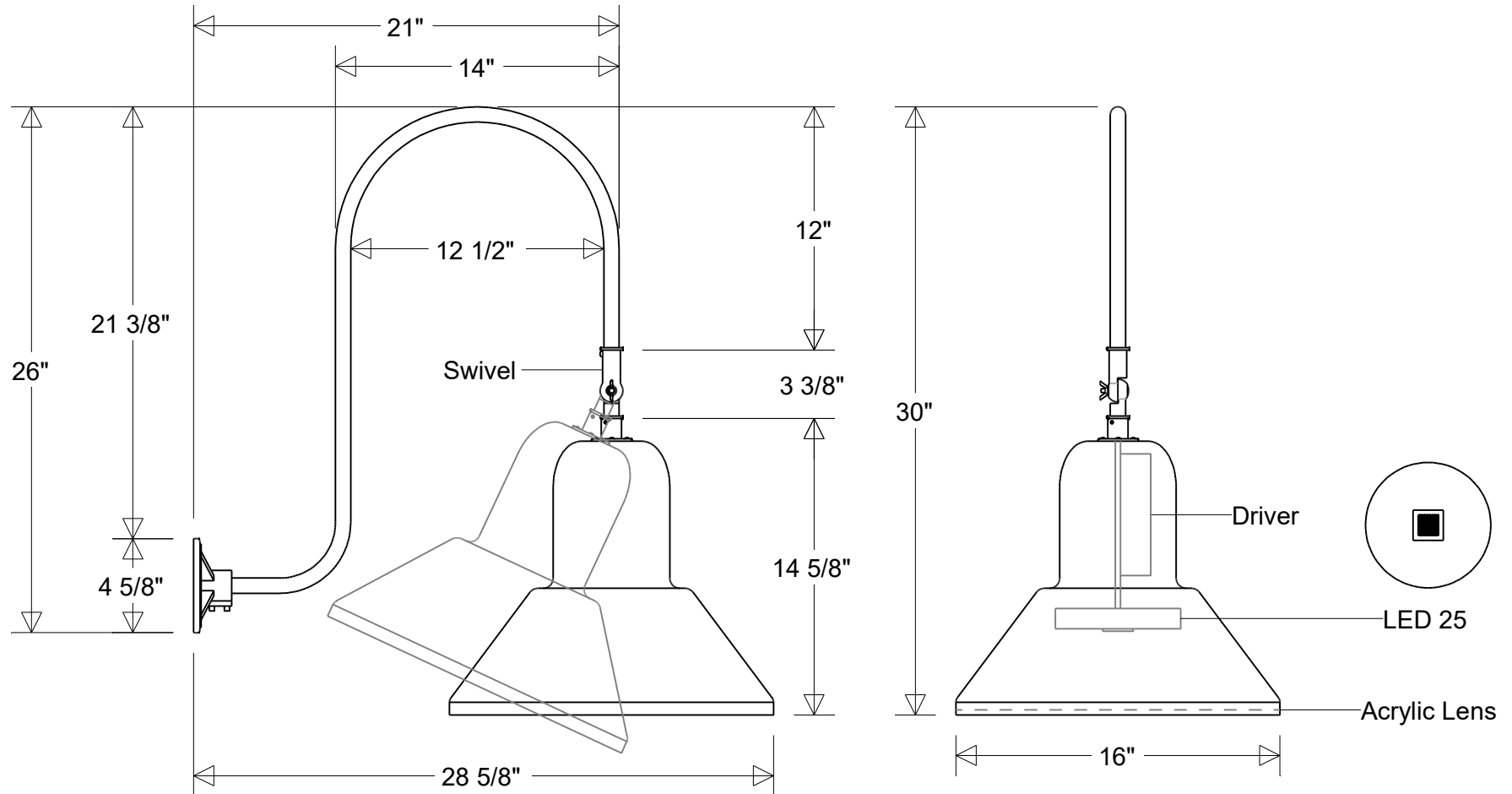

#37/16-874 ESW LED 25 NonDimm

16" Dia | 28 5/8" Ext | 30" H

Shade: #37/16A LED 25 NonDimm | Arm: #874 ESW

Lamp: 25 W LED

CCT: 3K or 4K | Others
 50W MH Equivalent

80 CRI
 120-277 V
 Non-Dimming

Finish:

29 Oven Baked
 Powder Coated Paints

Material:
 Aluminum
 Acrylic Lens

Drawn:

CB
 04/2026

Scale:

1/8

Approvals

Note:

All dimensions are nominal.
 Actual dimensions may vary.