

Revisions			Date	Approved
Zone	Rev	Description		

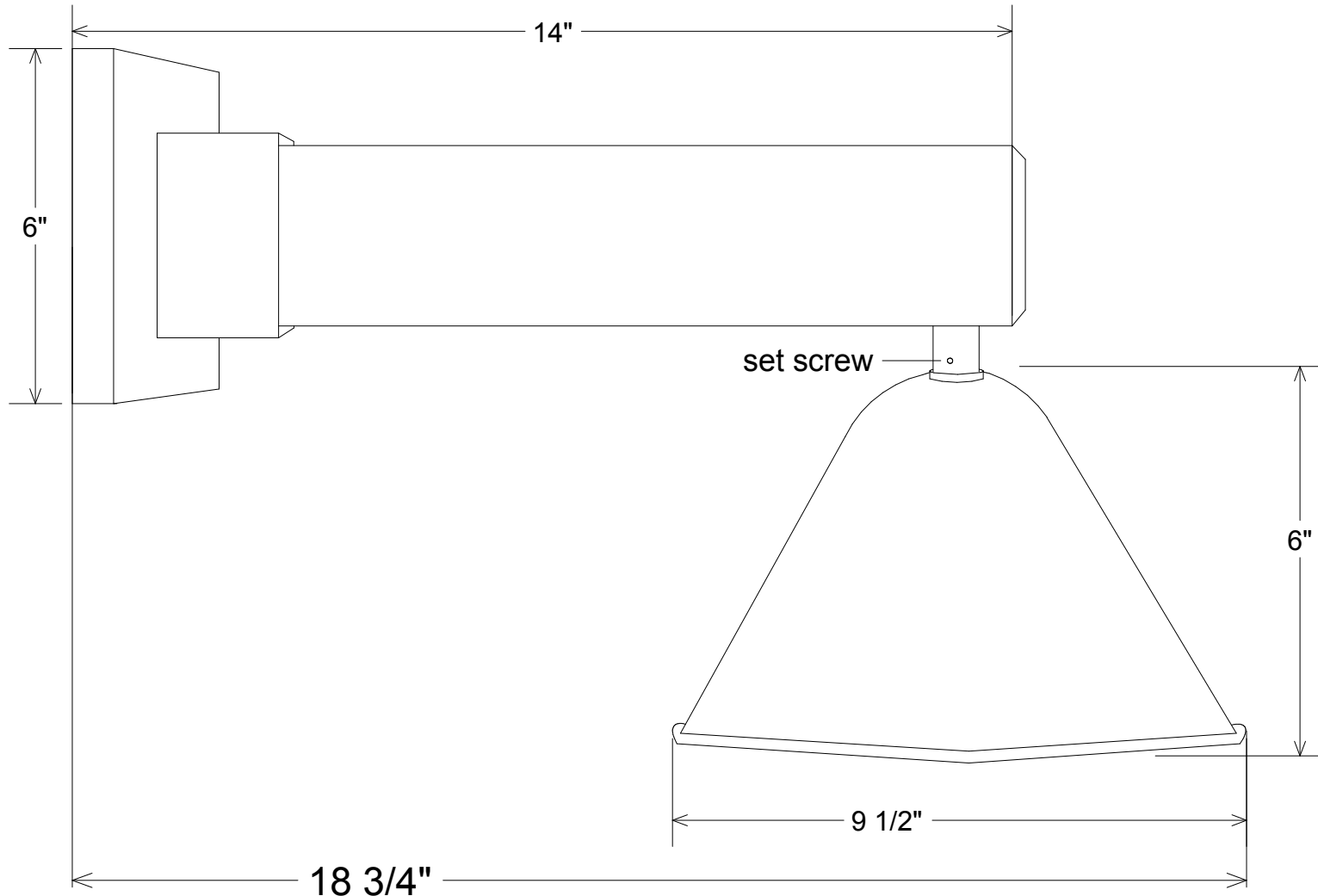

Unless Otherwise Specified: Dimensions in Inches Tolerances: Fractional ± Angular: Mach ± Bend ± Two Place Decimal ± Three Place Decimal ±	Drawn T.A.R.	Date 11/18/09	Primelite Mfg. Corp. 24/861	
	Checked ENG Appr.			
	MFR Appr.			
	QA			
	Comments CAD Generated Drawing Do Not Manually Update			
Construction: All Aluminum	Size A		Drawing No. 0001	Rev A
Pipe Size: 1/2"	Scale 1:4		CAD File	Sheet 1 of 1
Lamp: 1-100A				