



# Primelite Manufacturing Corp.

407 S Main St, Freeport, NY 11520  
 Phone: (516) 868-4411 | Fax: (516) 868-4609  
 sales@primelite-mfg.com | www.primelite-mfg.com

**PROUDLY MADE IN THE USA SINCE 1962!**  
**"SPECIALTIES ARE OUR SPECIALTY!"**

Job Info

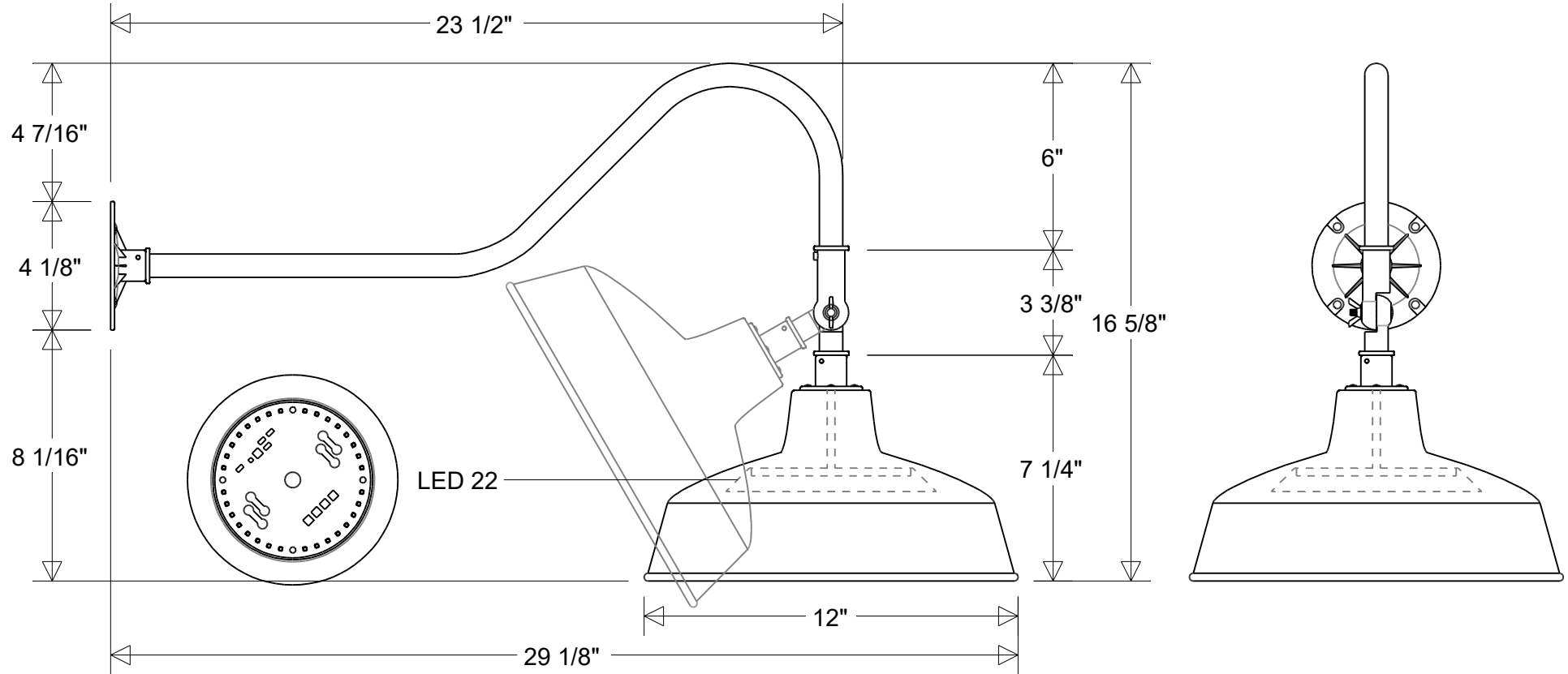

## #23/12-850 ESW LED 22

12" Dia | 29 1/8" Ext | 16 5/8" H

Shade: #23/12A | Arm #850 | Swivel: #ESW

**Lamp: 22 W LED**

3K: 1950 Lumens  
 4K: 2130 Lumens

**Voltage:**  
 120 V

**Finish:**

29 Oven Baked  
 Powder Coated Paints

**Material:**  
 Aluminum

**Drawn:**

CB  
 03/2025

**Scale:**

1/5

**Approvals**

**Note:**  
 All dimensions are nominal.  
 Actual dimensions may vary.