



Primelite Manufacturing Corp.

407 S Main St, Freeport, NY 11520
 Phone: (516) 868-4411 | Fax: (516) 868-4609
 sales@primelite-mfg.com | www.primelite-mfg.com

PROUDLY MADE IN THE USA SINCE 1962!
"SPECIALTIES ARE OUR SPECIALTY!"

Job Info

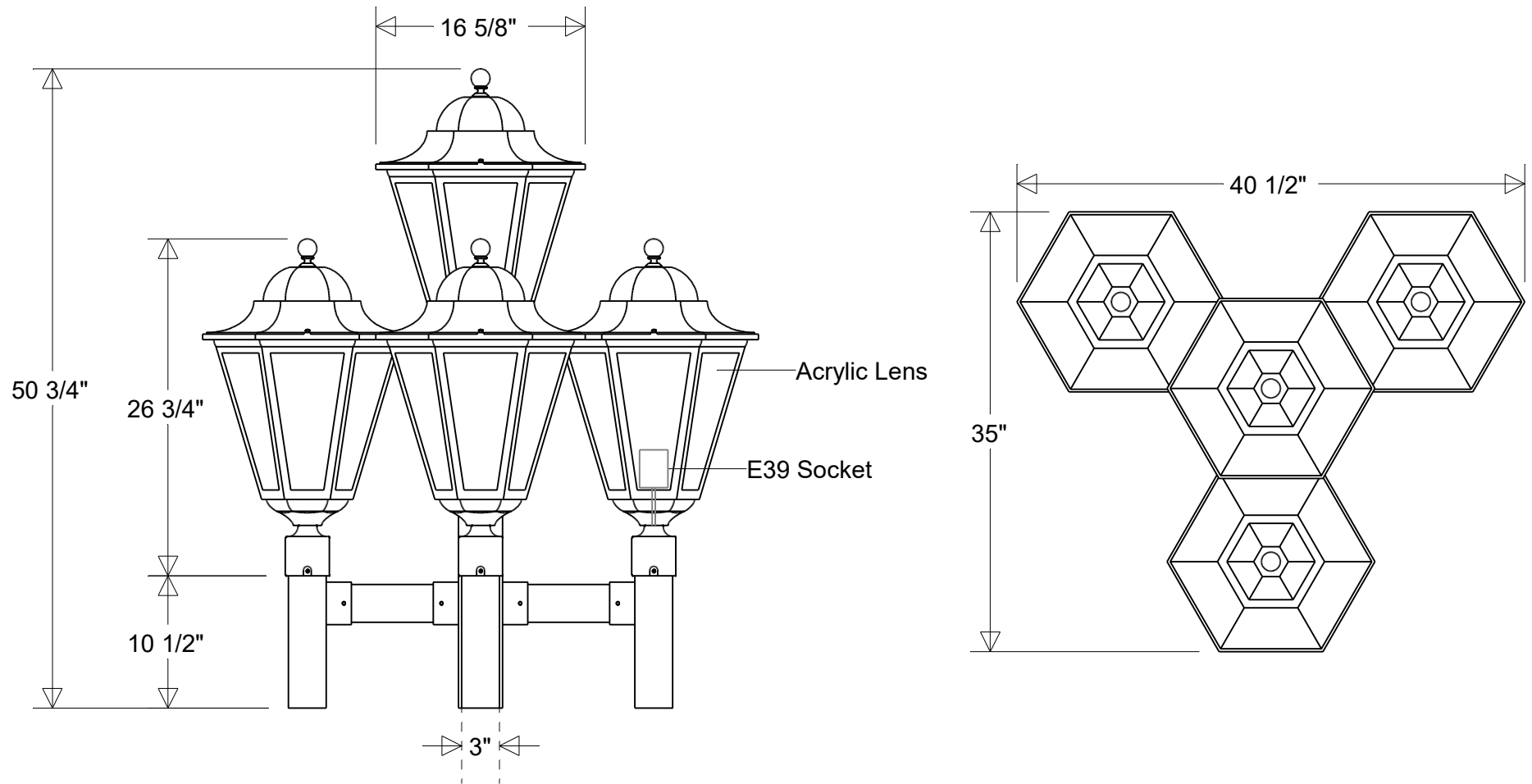

#1325/* H4A E39

40 1/2" W | 35" Ext | 50 3/4" H | 3" Post Fitter
 Lens: Smoke (*1) | White (*3) | Clear (*4) | Frost (*5)

Lamp: E39 Socket Max Wattage: 300 W Number of Sockets: 4 120 V	Finish: 29 Oven Baked Powder Coated Paints	Drawn: CB 03/2026	Scale: 1 / 12.5	Approvals
	Material: Aluminum Acrylic Lens	Note: All dimensions are nominal. Actual dimensions may vary.		