



# Primelite Manufacturing Corp.

407 S Main St, Freeport, NY 11520  
 Phone: (516) 868-4411 | Fax: (516) 868-4609  
 sales@primelite-mfg.com | www.primelite-mfg.com

**PROUDLY MADE IN THE USA SINCE 1962!**  
**"SPECIALTIES ARE OUR SPECIALTY!"**

Job Info

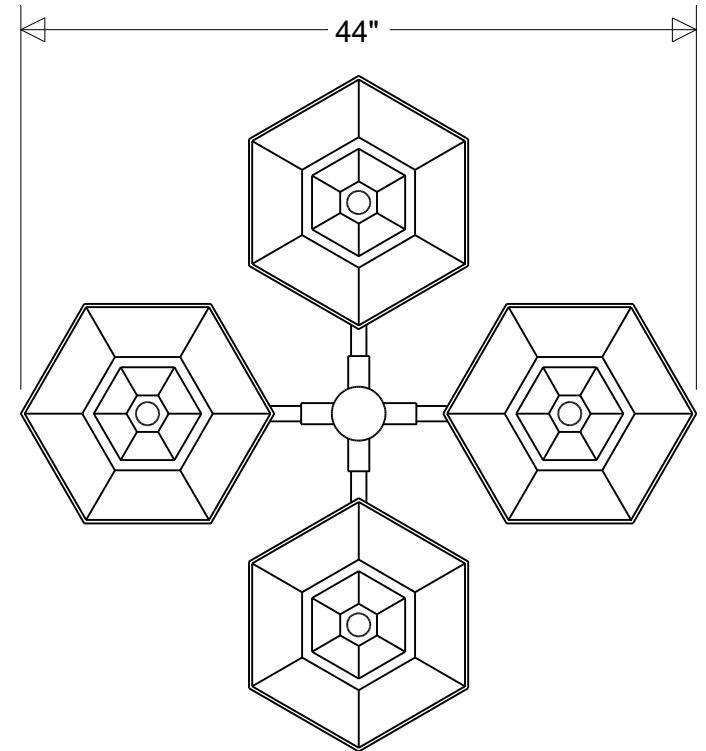
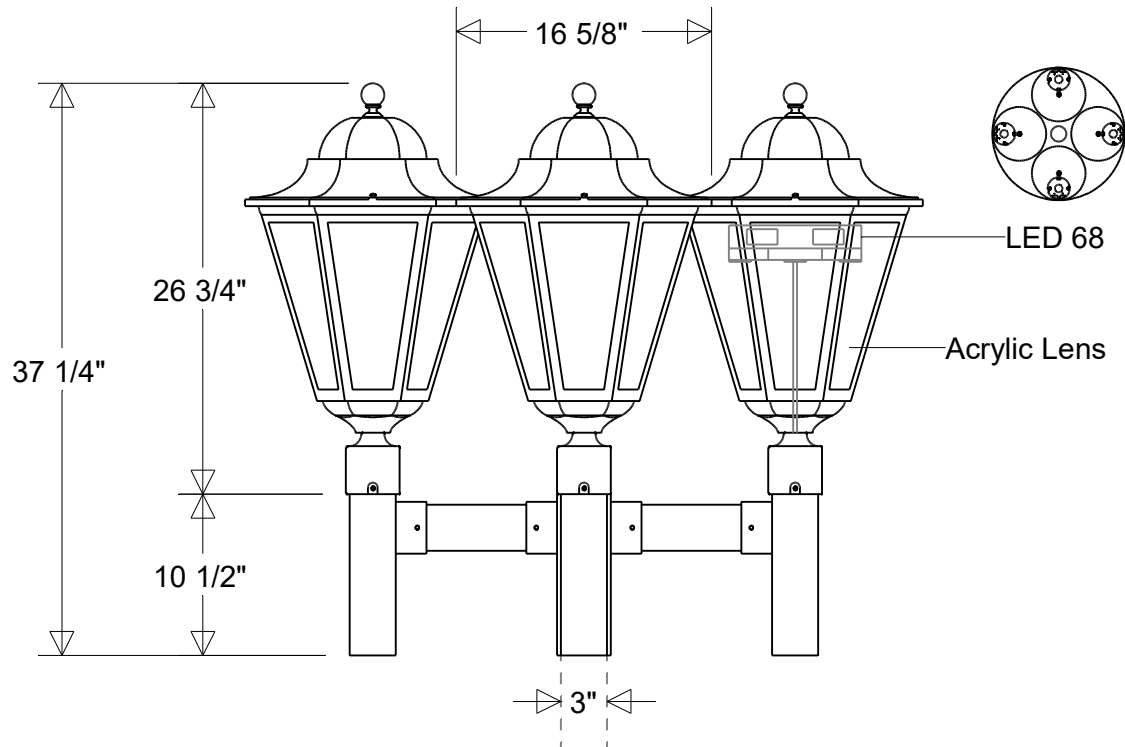

## #1325/\* H4 LED 68 NonDimm

44" W | 44" Ext | 37 1/4" H | 3" Post Fitter  
 Lens: Smoke (\*1) | White (\*3) | Clear (\*4) | Frost (\*5)

**Lamp:** 68 W LED x4  
 CCT: 3K or 4K | Others  
 125W MH Equivalent  
 80 CRI  
 120-277 V  
 Non-Dimming

**Finish:**  
 29 Oven Baked  
 Powder Coated Paints  
**Material:**  
 Aluminum  
 Acrylic Lens

**Drawn:**  
 CB  
 03/2026

**Scale:**  
 1 / 12.5

**Note:**  
 All dimensions are nominal.  
 Actual dimensions may vary.

Approvals
