



Primelite Manufacturing Corp.

407 S Main St, Freeport, NY 11520
 Phone: (516) 868-4411 | Fax: (516) 868-4609
 sales@primelite-mfg.com | www.primelite-mfg.com

PROUDLY MADE IN THE USA SINCE 1962!
"SPECIALTIES ARE OUR SPECIALTY!"

Job Info

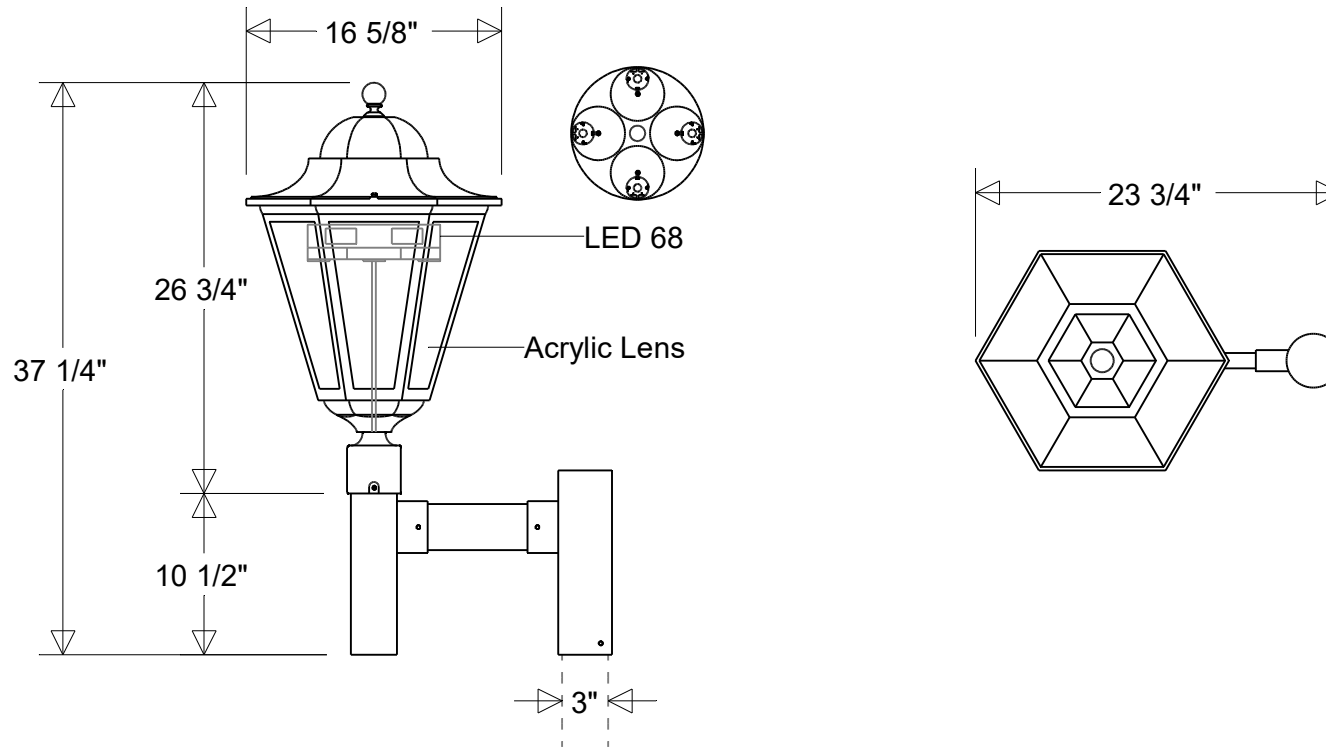

#1325/* H1 LED 68 Dimm

16 5/8" W | 23 3/4" Ext | 37 1/4" H | 3" Post Fitter
 Lens: Smoke (*1) | White (*3) | Clear (*4) | Frost (*5)

Lamp: 68 W LED CCT: 3K or 4K Others 125W MH Equivalent 80 CRI 120-277 V 0-10 V Dimming	Finish: 29 Oven Baked Powder Coated Paints Material: Aluminum Acrylic Lens	Drawn: CB 03/2026 Note: All dimensions are nominal. Actual dimensions may vary.	Scale: 1 / 12.5	Approvals	