



Primelite Manufacturing Corp.

407 S Main St, Freeport, NY 11520
 Phone: (516) 868-4411 | Fax: (516) 868-4609
 sales@primelite-mfg.com | www.primelite-mfg.com

PROUDLY MADE IN THE USA SINCE 1962!
"SPECIALTIES ARE OUR SPECIALTY!"

Job Info

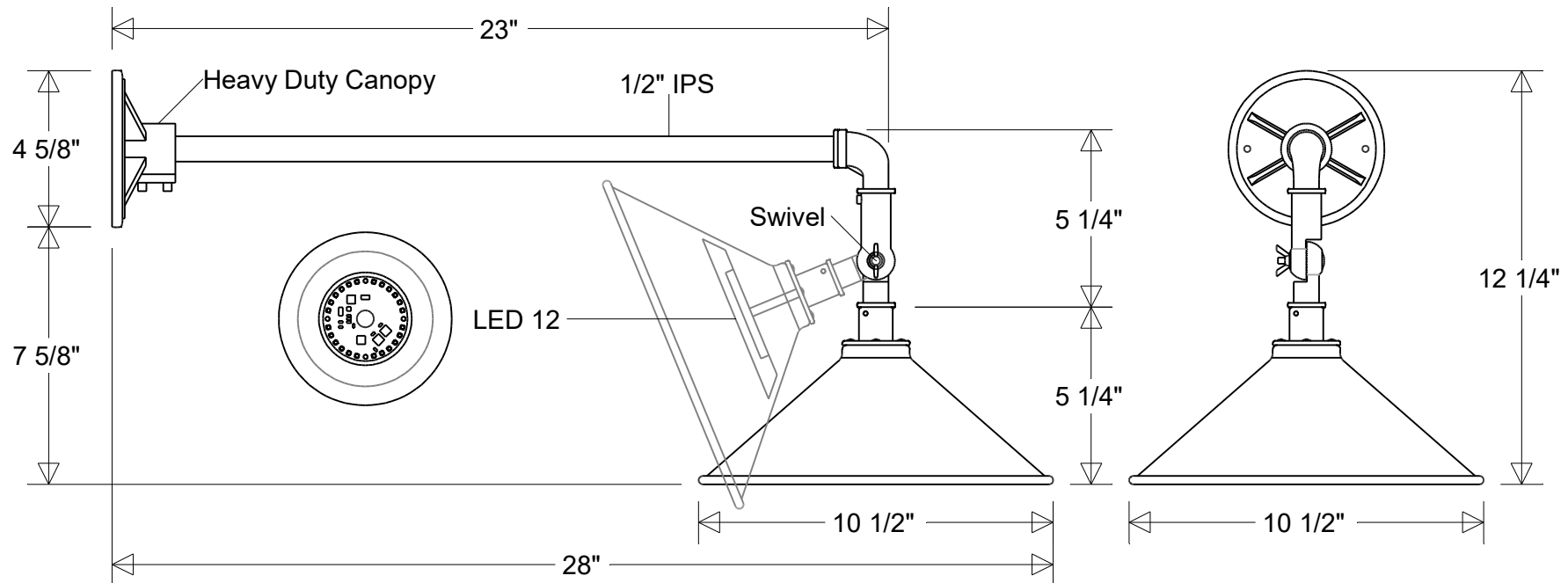

#111/10-855 ESW HDC LED 12

10 1/2" Dia | 28" Ext | 12 1/4" H
 Shade: #111/10A LED 12 | Arm: #855 ESW HDC

Lamp: 12 W LED
 CCT: 3K or 4K
 75W Inc Equivalent
 80 CRI
 120V
 Electronic Dimming

Finish:
 29 Oven Baked
 Powder Coated Paints
Material:
 Aluminum

Drawn:
 CB
 04/2026
Scale:
 1/5
Note:
 All dimensions are nominal.
 Actual dimensions may vary.

Approvals	