

Revisions				
Zone	Rev	Description	Date	Approved

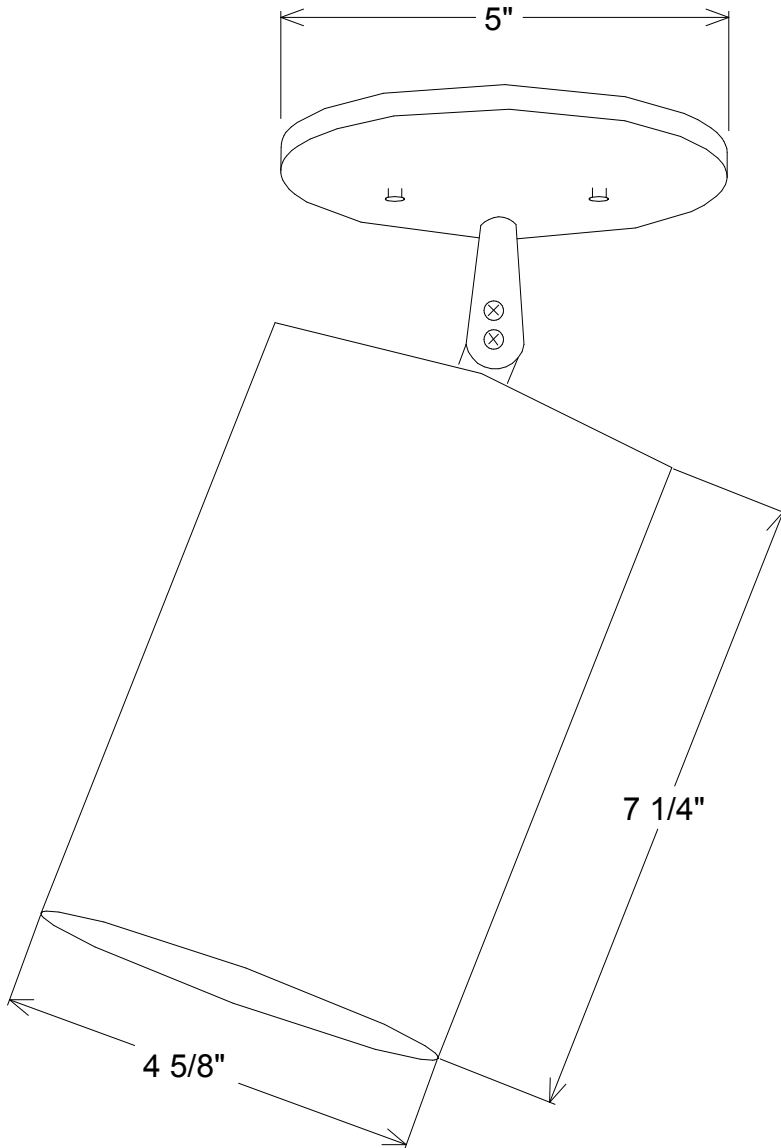

<b>Unless Otherwise Specified:</b> Dimensions in Inches Tolerances: Fractional ± Angular: Mach ± Bend ± Two Place Decimal ± Three Place Decimal ±		<b>Name</b>	<b>Date</b>	<b>Primelite Mfg. Corp.</b>		
	<b>Drawn</b>	T.A.R.	09/14/10			
	<b>Checked</b>					
	<b>ENG Appr.</b>					
	<b>MFR Appr.</b>					
	<b>QA</b>			<b>Size</b>	<b>Drawing No.</b>	<b>Rev</b>
<b>Construction: All Aluminum</b>	<b>Comments</b> CAD Generated Drawing Do Not Manually Update			<b>A</b>	<b>0001</b>	<b>A</b>
<b>Lamp: 1-75A</b>				<b>Scale</b>	<b>CAD File</b>	<b>Sheet</b>
				<b>1:2</b>		