

Revisions				
Zone	Rev	Description	Date	Approved

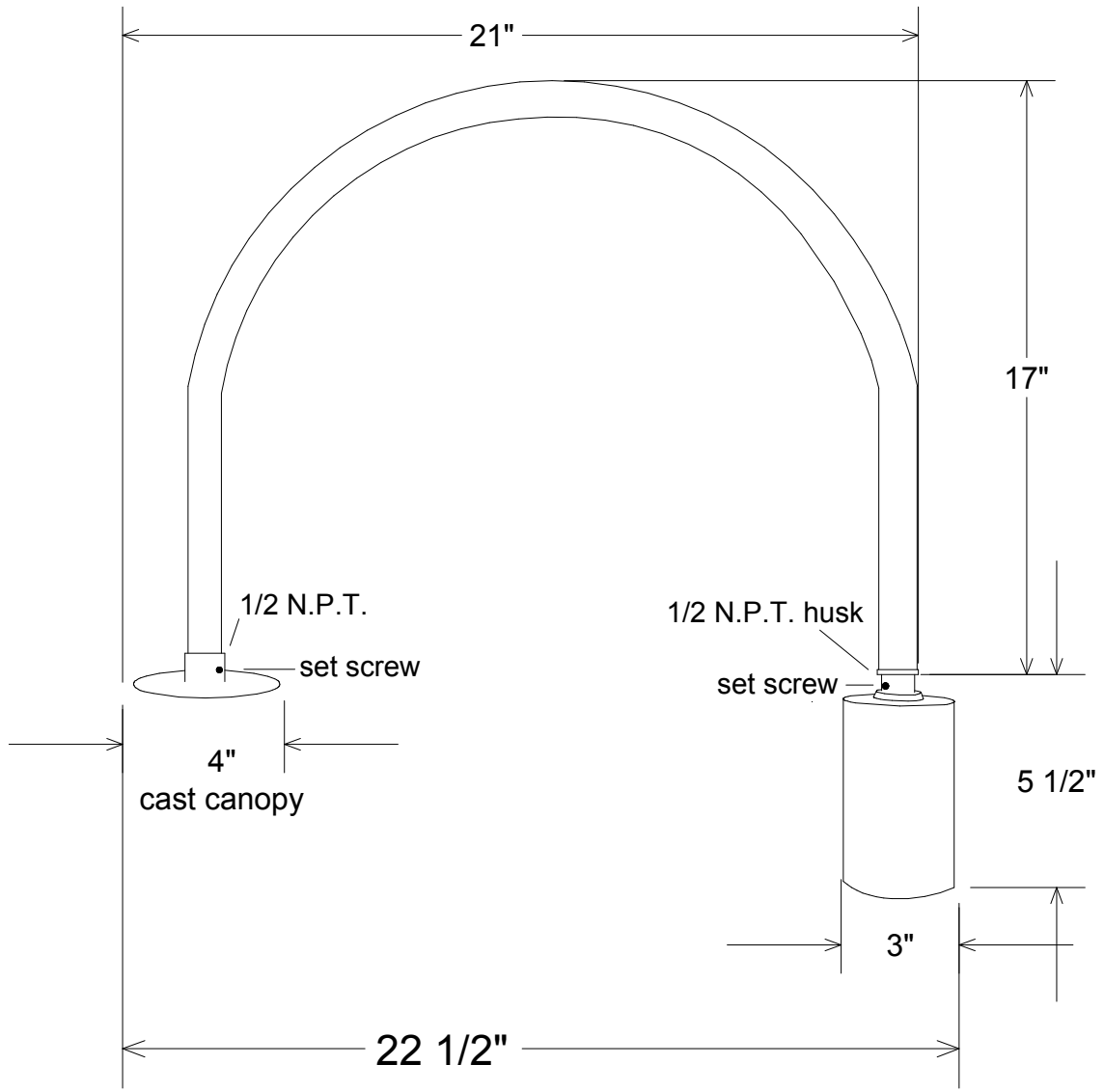

<b>Unless Otherwise Specified:</b> Dimensions in Inches Tolerances: Fractional ± Angular: Mach ± Bend ± Two Place Decimal ± Three Place Decimal ±	Name	Date	<b>Primelite Mfg. Corp.</b>  <b>57/852</b>		
	Drawn	T.A.R.			10/23/09
	Checked				
	ENG Appr.				
	MFR Appr.				
	QA				
	Comments		Size	Drawing No.	Rev
Construction: All Aluminum	CAD Generated Drawing Do Not Manually Update		A	0001	A
Pipe Size: 1/2"			Scale	CAD File	Sheet
Lamp: 1-60A			1:7		1 of 1