

Revisions				
Zone	Rev	Description	Date	Approved

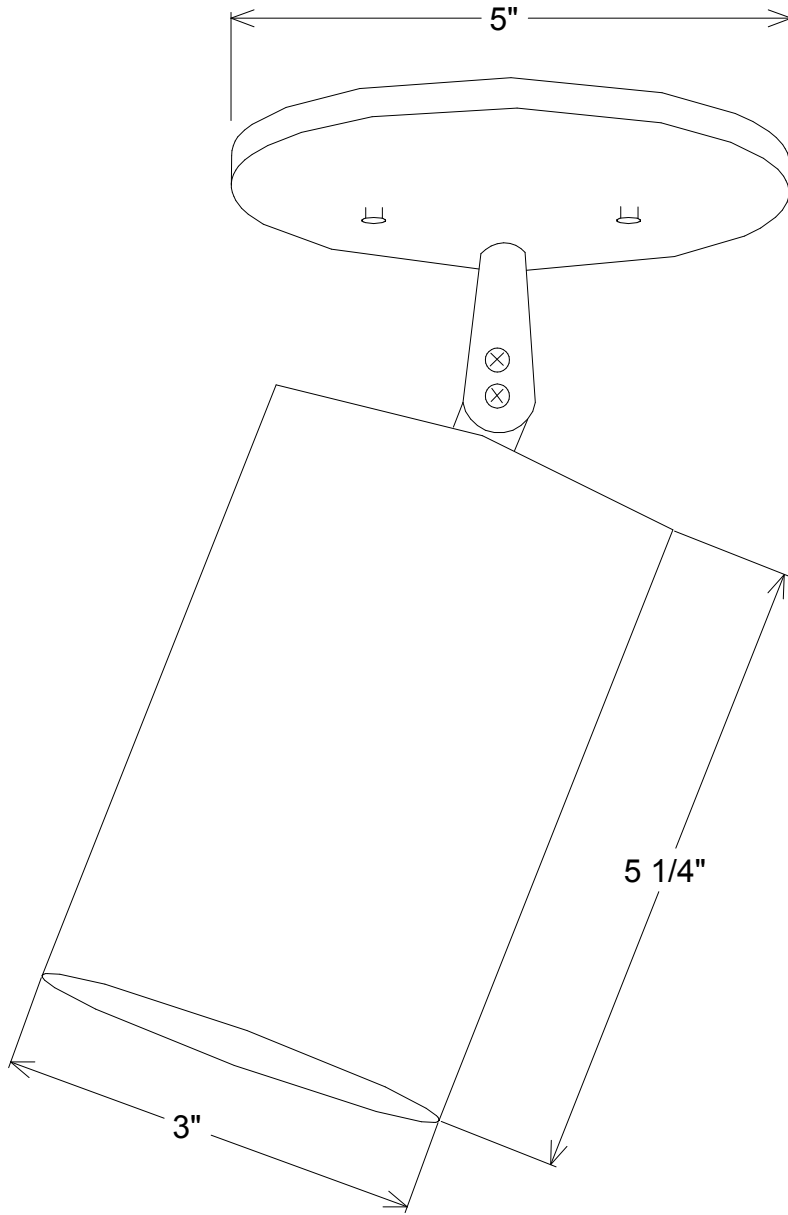

Unless Otherwise Specified: Dimensions in Inches Tolerances: Fractional ± Angular: Mach ± Bend ± Two Place Decimal ± Three Place Decimal ±		Name	Date	Primelite Mfg. Corp.					
	Drawn	T.A.R.	09/14/10			57/60			
	Checked								
	ENG Appr.								
	MFR Appr.								
	QA			Size	Drawing No.	Rev			
Construction: All Aluminum	Comments		CAD Generated Drawing Do Not Manually Update		A	0001	A		
Lamp: 1-60A					Scale	1:2	CAD File	Sheet	1 of 1