

Revisions			Date	Approved
Zone	Rev	Description		

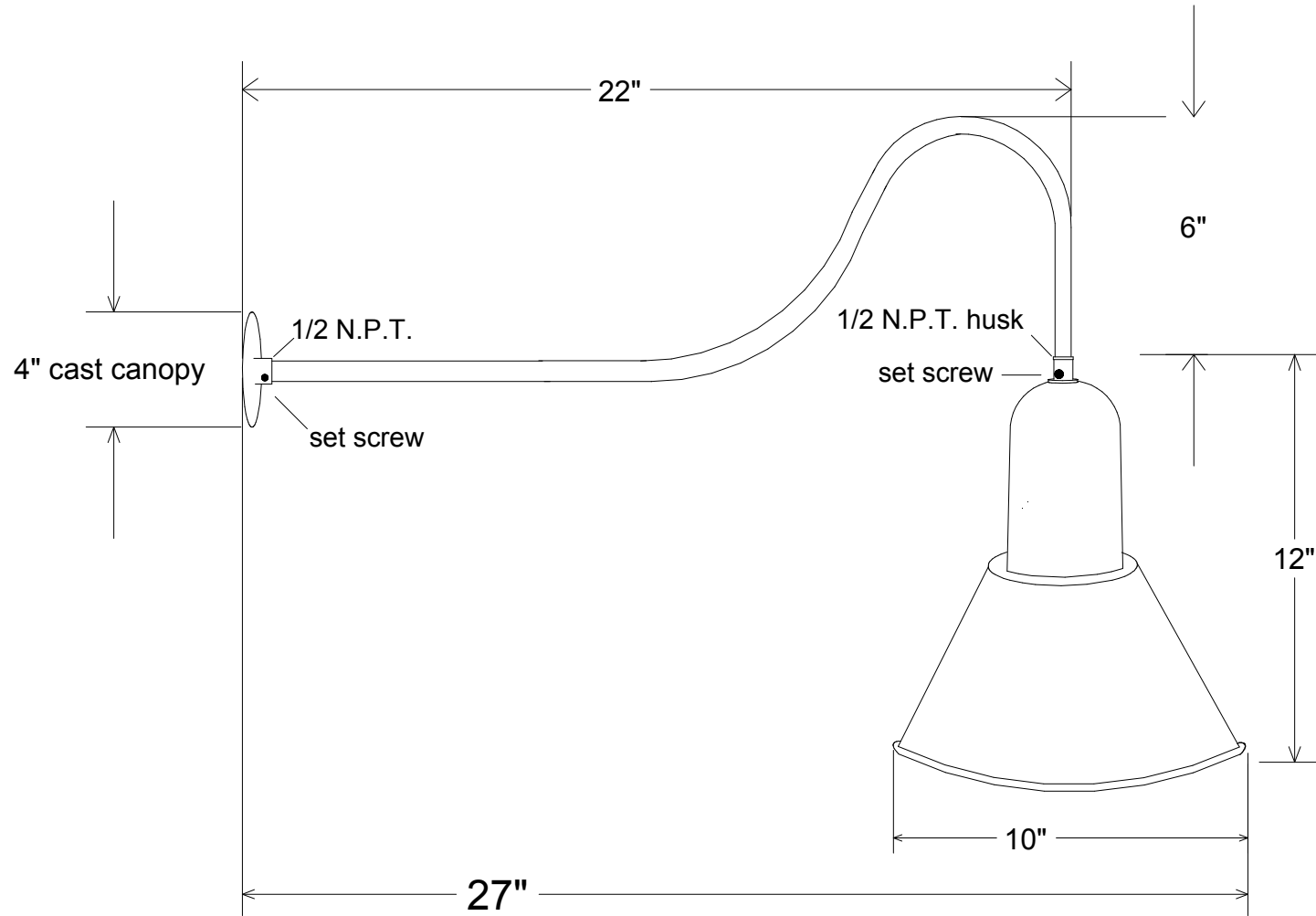

<b>Unless Otherwise Specified:</b> Dimensions in Inches Tolerances: Fractional ± Angular: Mach ± Bend ± Two Place Decimal ± Three Place Decimal ±	<b>Drawn</b> T.A.R.	<b>Date</b> 10/14/09	<b>Primelite Mfg. Corp.</b>  <b>37-10/857</b>  10" Balast Shade Angle Straight Down
	<b>Checked</b> ENG Appr.		
	<b>MFR Appr.</b> MFR Appr.		
	<b>QA</b> QA		
	<b>Comments</b> CAD Generated Drawing Do Not Manually Update		
<b>Construction: All Aluminum</b>	<b>Size</b> <b>A</b>	<b>Drawing No.</b> <b>0001</b>	<b>Rev</b> <b>A</b>
<b>Pipe Size: 1/2"</b>	<b>Scale</b> <b>1:5</b>	<b>CAD File</b>	<b>Sheet</b> <b>1 of 1</b>
<b>Lamp: 1-150A</b>			