

Revisions				
Zone	Rev	Description	Date	Approved

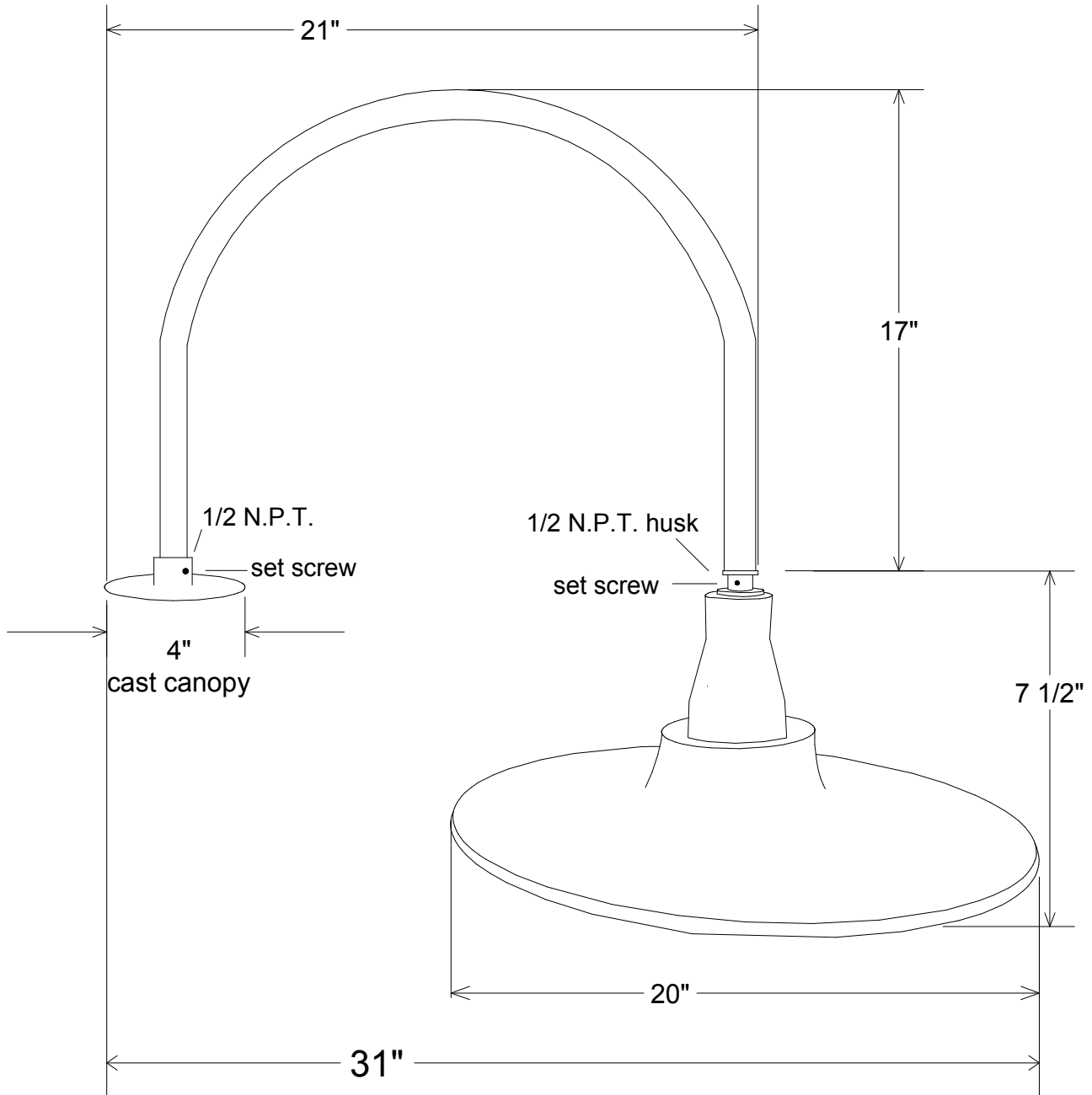

Unless Otherwise Specified: Dimensions in Inches Tolerances: Fractional ± Angular: Mach ± Bend ± Two Place Decimal ± Three Place Decimal ±	Name	Date	Primelite Mfg. Corp. 34-20/852			
	Drawn	T.A.R.				10/22/09
	Checked					
	ENG Appr.					
	MFR Appr.					
QA			Size	Drawing No.	Rev	
Construction: All Aluminum	Comments		A	0001	A	
Pipe Size: 1/2"	CAD Generated Drawing Do Not Manually Update		Scale	CAD File	Sheet	
Lamp: 1-200A			1:7		1 of 1	