

Revisions				
Zone	Rev	Description	Date	Approved

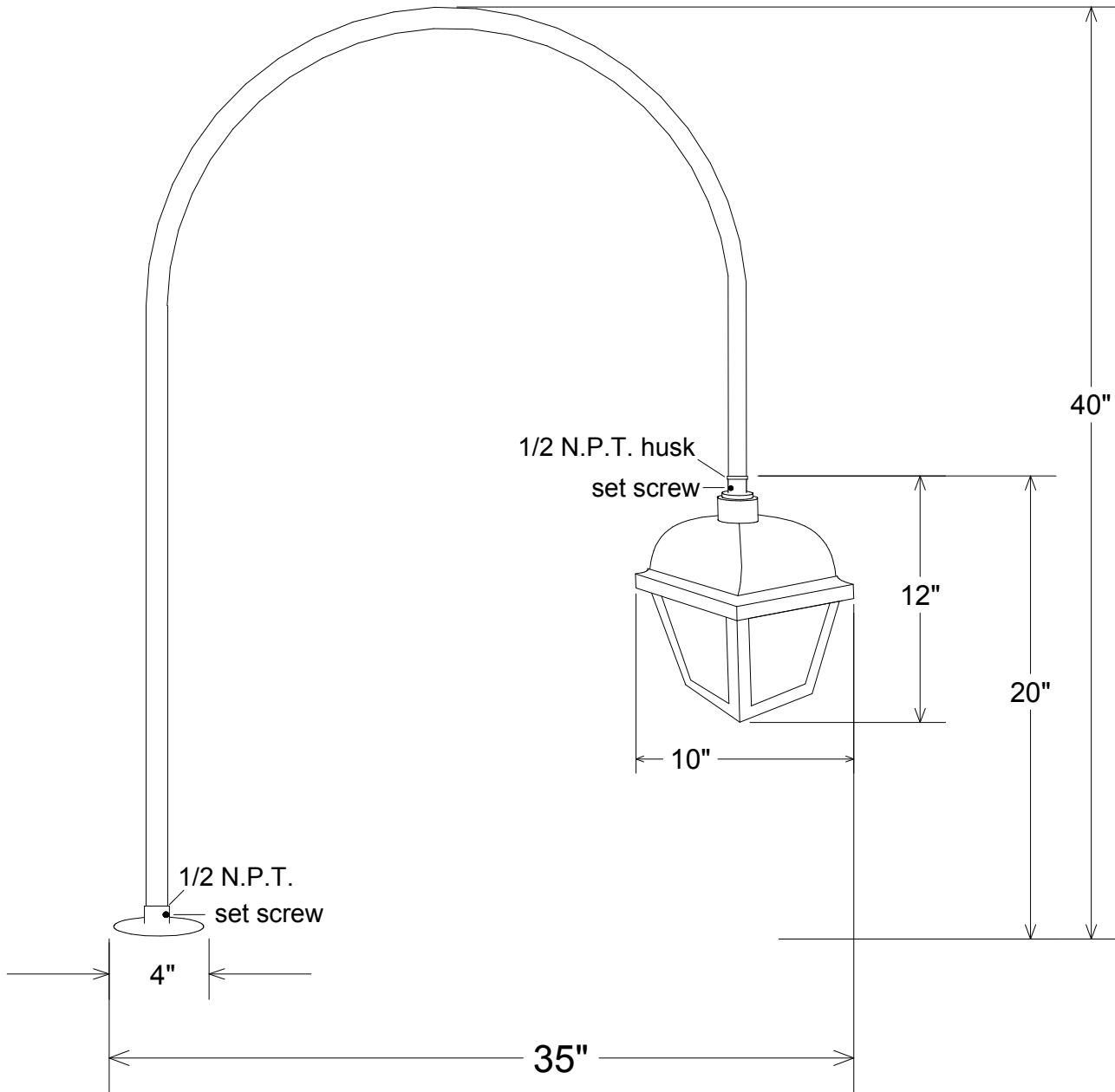

Unless Otherwise Specified: Dimensions in Inches Tolerances: Fractional ± Angular: Mach ± Bend ± Two Place Decimal ± Three Place Decimal ±	Name	Date	Primelite Mfg. Corp. 329/854		
	Drawn	T.A.R.			10/27/09
	Checked				
	ENG Appr.				
	MFR Appr.				
QA			Size	Drawing No.	Rev
Construction: All Aluminum	Comments		A	0001	A
Pipe Size: 1/2"	CAD Generated Drawing Do Not Manually Update		Scale	CAD File	Sheet
Lamp: 1-150A			1:7		1 of 1