

Revisions				
Zone	Rev	Description	Date	Approved

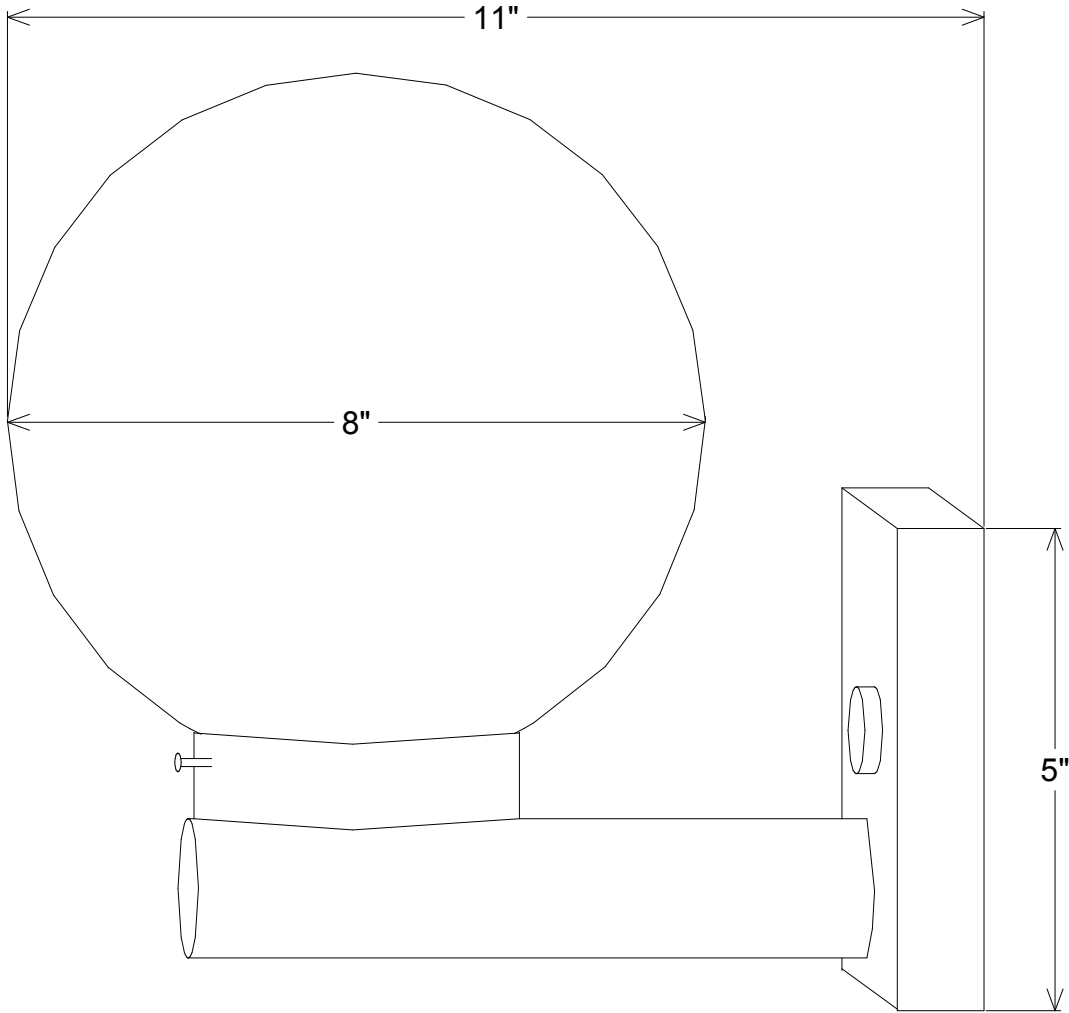

Unless Otherwise Specified: Dimensions in Inches Tolerances: Fractional ± Angular: Mach ± Bend ± Two Place Decimal ± Three Place Decimal ±		Name	Date	Primelite Mfg. Corp. 2784 Acrylic		
	Drawn	T.A.R.	09/28/10			
	Checked					
	ENG Appr.					
	MFR Appr.					
	QA			Size	Drawing No.	Rev
Construction: Aluminum, Acrylic	Comments			A	0001	A
	CAD Generated Drawing Do Not Manually Update			Scale	CAD File	Sheet
Lamp: 1-75A				1:2		1 of 1