

Revisions				
Zone	Rev	Description	Date	Approved

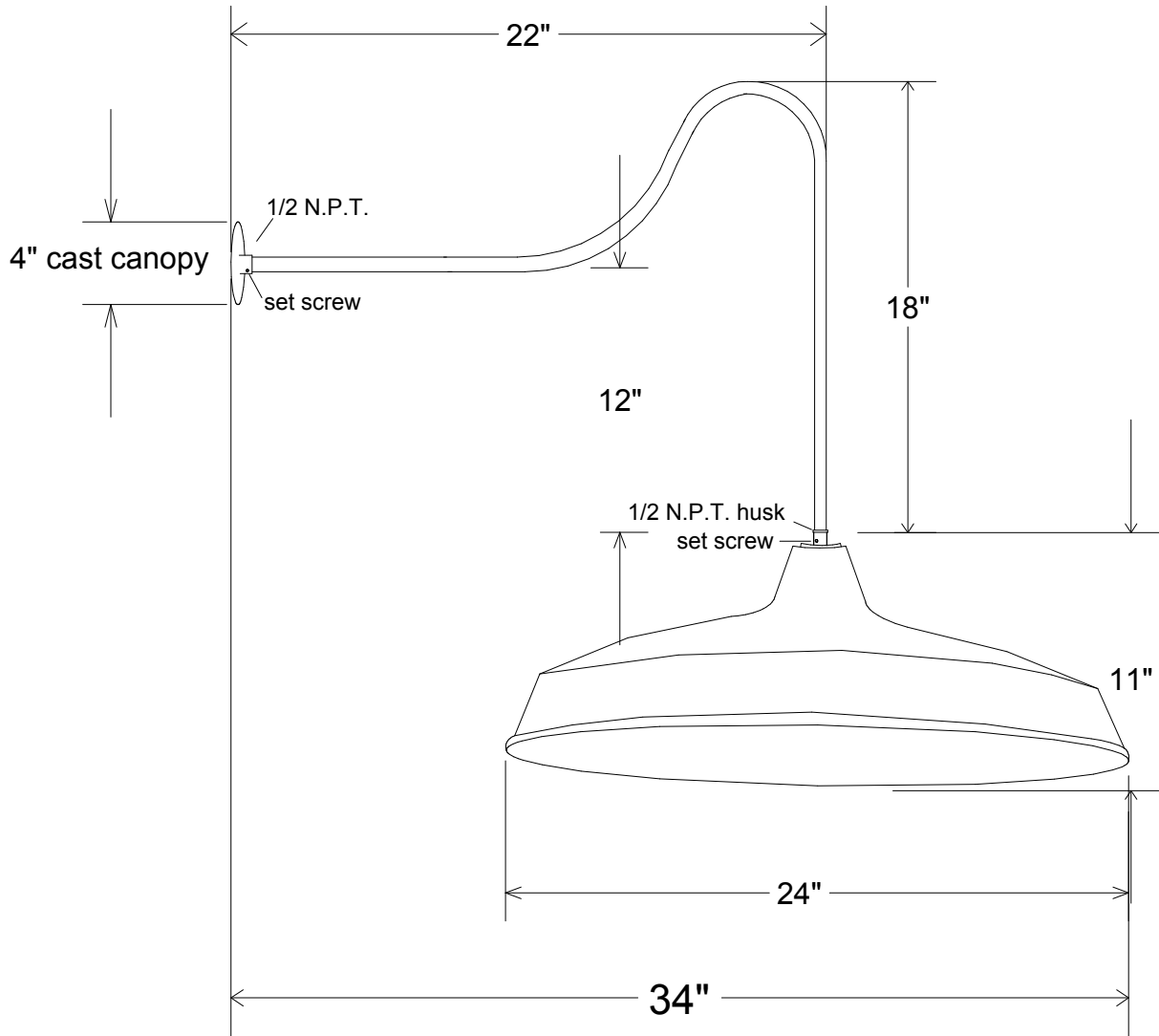

<b>Unless Otherwise Specified:</b> Dimensions in Inches Tolerances: Fractional ± Angular: Mach ± Bend ± Two Place Decimal ± Three Place Decimal ±	<b>Name</b>	<b>Date</b>	<b>Primelite Mfg. Corp.</b>  <b>23/24-860</b>		
	<b>Drawn</b>	T.A.R.			10/14/09
	<b>Checked</b>				
	<b>ENG Appr.</b>				
	<b>MFR Appr.</b>				
<b>QA</b>			<b>Size</b> <b>Drawing No.</b> <b>Rev</b> <b>A</b> <b>0001</b> <b>A</b>		
<b>Construction: All Aluminum</b>	<b>Comments</b>		<b>Scale</b> <b>CAD File</b> <b>Sheet</b> <b>1:6</b> <b>1 of 1</b>		
<b>Pipe Size: 1/2"</b>	CAD Generated Drawing Do Not Manually Update				
<b>Lamp: 1-200A</b>					