

| Revisions | | | Date | Approved |
|-----------|-----|-------------|------|----------|
| Zone | Rev | Description | | |
| | | | | |

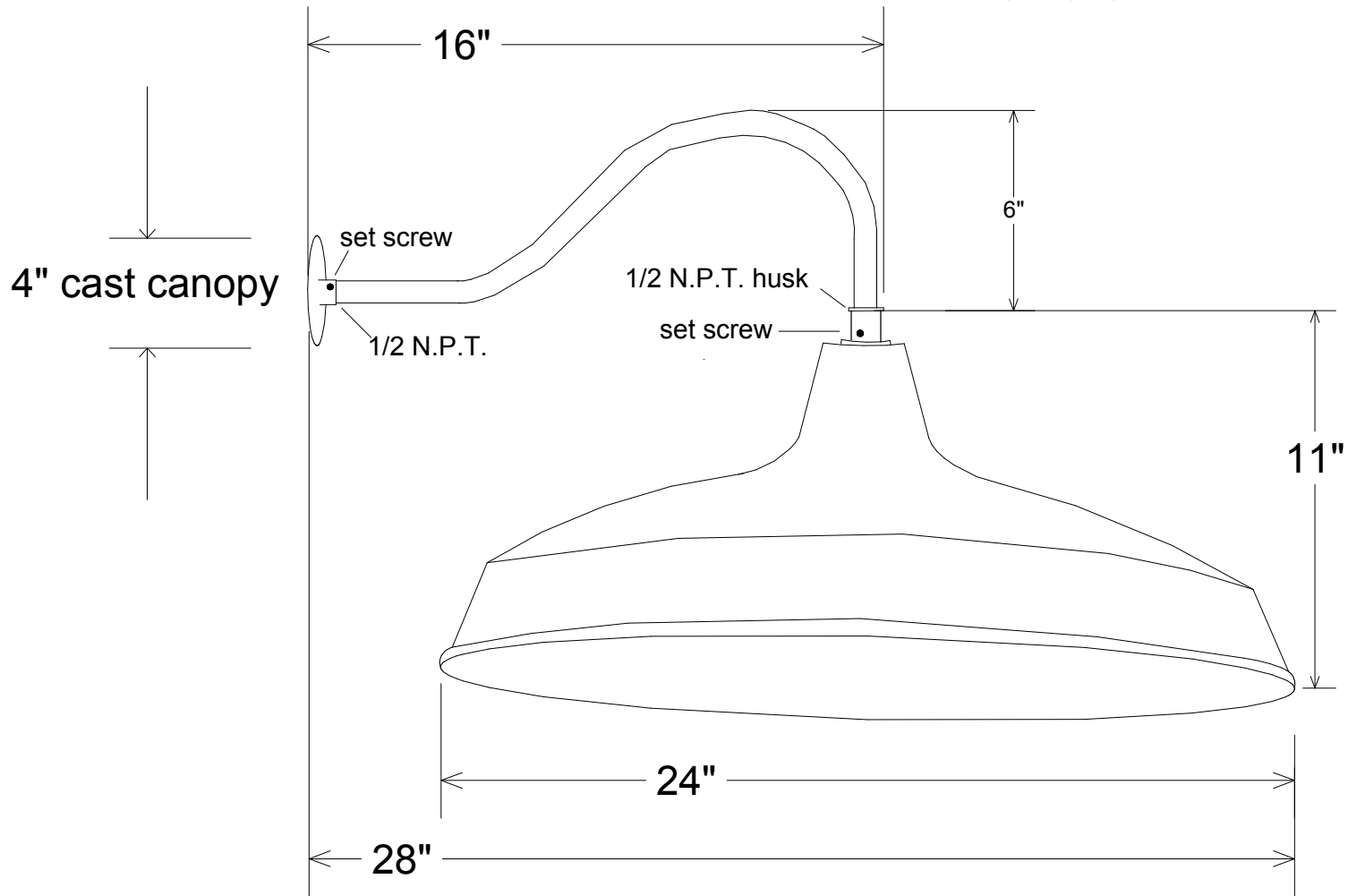

| | | | | | |
|--|--|-------------------------|---|-----------------------------------|-------------------------------|
| Unless Otherwise Specified: Dimensions in Inches Tolerances: Fractional ± Angular: Mach ± Bend ± Two Place Decimal ± Three Place Decimal ± | Drawn T.A.R. | Date 11/13/09 | Primelite Mfg. Corp. 23/24-859 | | |
| | Checked | | | | |
| | ENG Appr. | | | | |
| | MFR Appr. | | | | |
| | QA | | | | |
| Construction: All Aluminum | Comments CAD Generated Drawing Do Not Manually Update | | Size A | Drawing No. 0001 | Rev A |
| Pipe Size: 1/2" | | | Scale 1:5 | CAD File | Sheet 1 of 1 |
| Lamp: 1-200A | | | | | |