

Revisions				
Zone	Rev	Description	Date	Approved

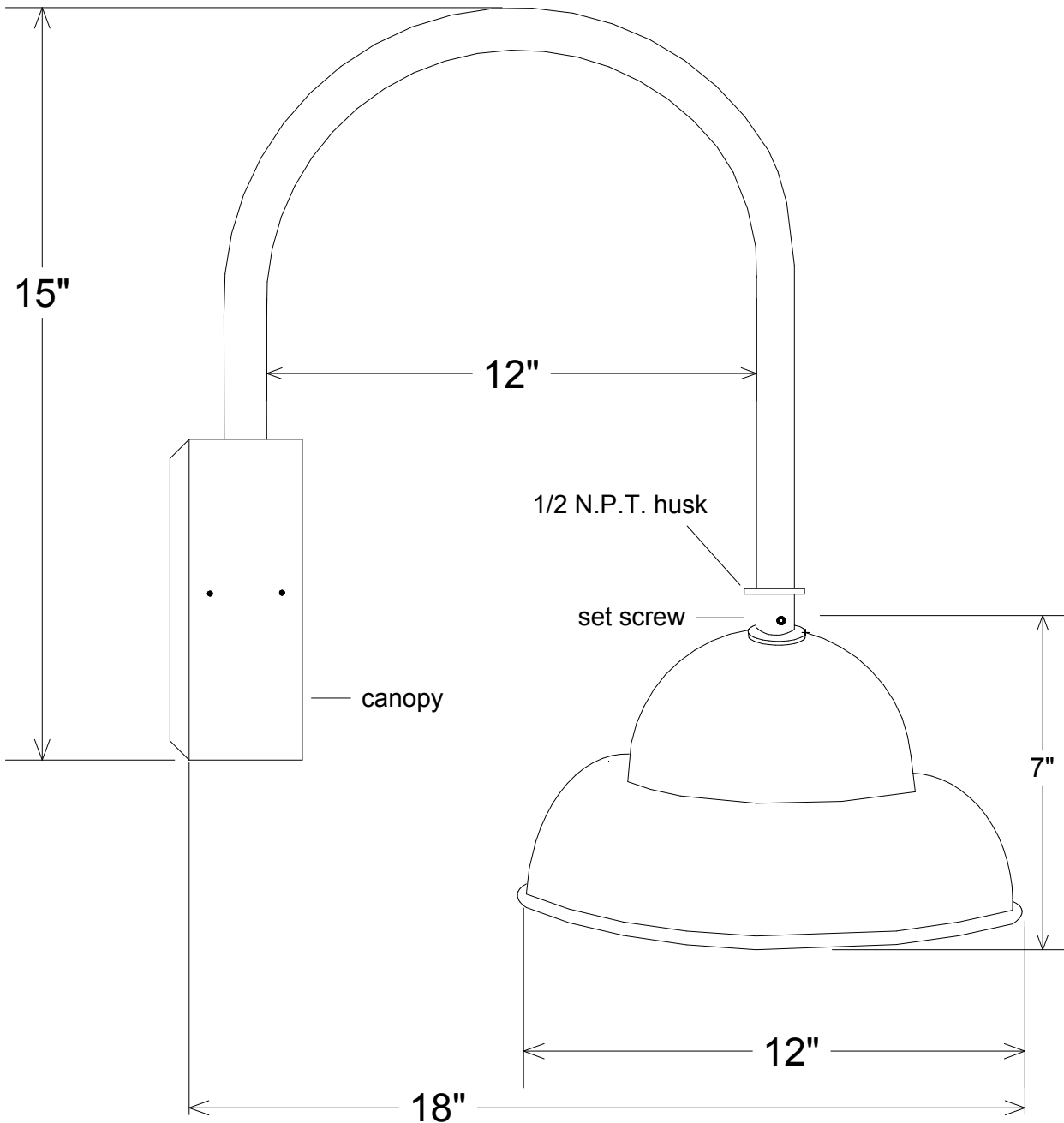

Unless Otherwise Specified: Dimensions in Inches Tolerances: Fractional ± Angular: Mach ± Bend ± Two Place Decimal ± Three Place Decimal ±	Name		Date	Primelite Mfg. Corp.		
	Drawn	T.A.R.	11/23/09			
	Checked			17/863		
	ENG Appr.					
	MFR Appr.					
QA				Size	Drawing No.	Rev
Construction: All Aluminum Pipe Size: 1/2" Lamp: 1-200A	Comments CAD Generated Drawing Do Not Manually Update			A	0001	A
				Scale	CAD File	Sheet
				1:4		1 of 1