

Revisions				
Zone	Rev	Description	Date	Approved

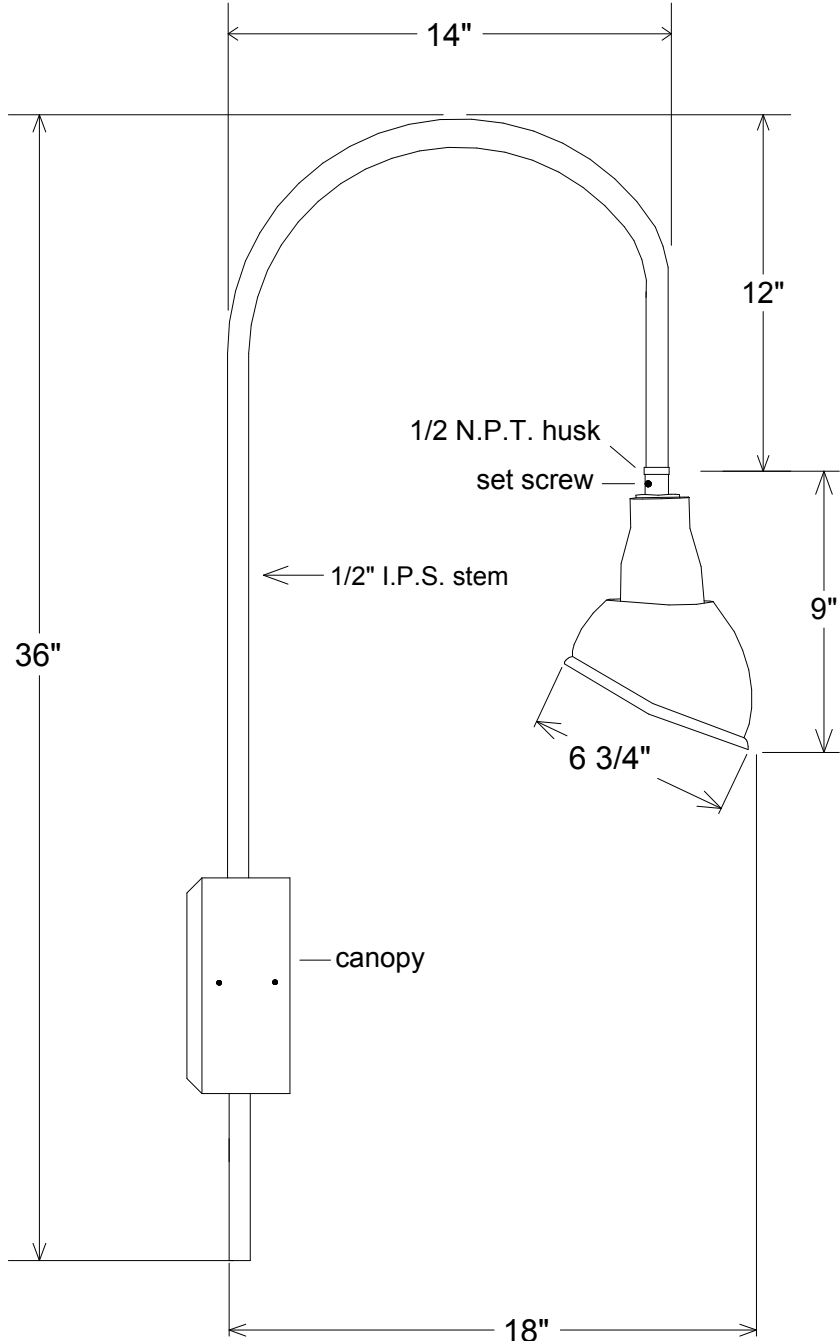

<b>Unless Otherwise Specified:</b> Dimensions in Inches Tolerances: Fractional ± Angular: Mach ± Bend ± Two Place Decimal ± Three Place Decimal ±	Name		Date	<b>Primelite Mfg. Corp.</b>		
	Drawn	T.A.R.	05/24/10			
	Checked			<b>15/862</b>		
	ENG Appr.					
	MFR Appr.					
QA				Size	Drawing No.	Rev
<b>Construction: All Aluminum</b> <b>Pipe Size: 1/2"</b> <b>Lamp: 1-100A</b>	Comments CAD Generated Drawing Do Not Manually Update			<b>A</b>	<b>0001</b>	<b>A</b>
				Scale	CAD File	Sheet
				<b>1:6</b>		<b>1 of 1</b>