

Small Ballast Pot Canopy

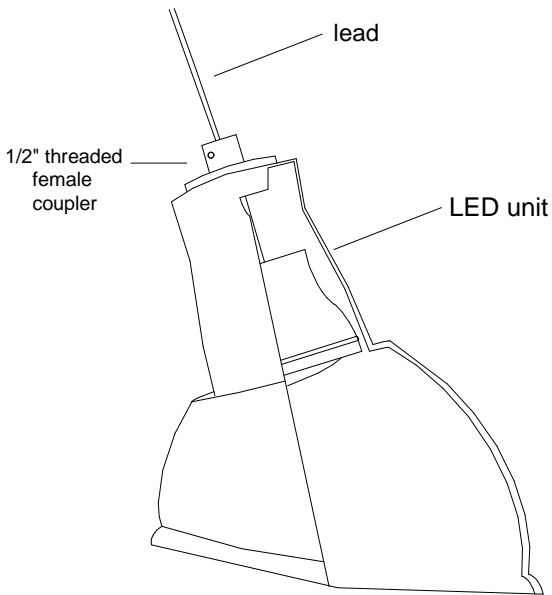
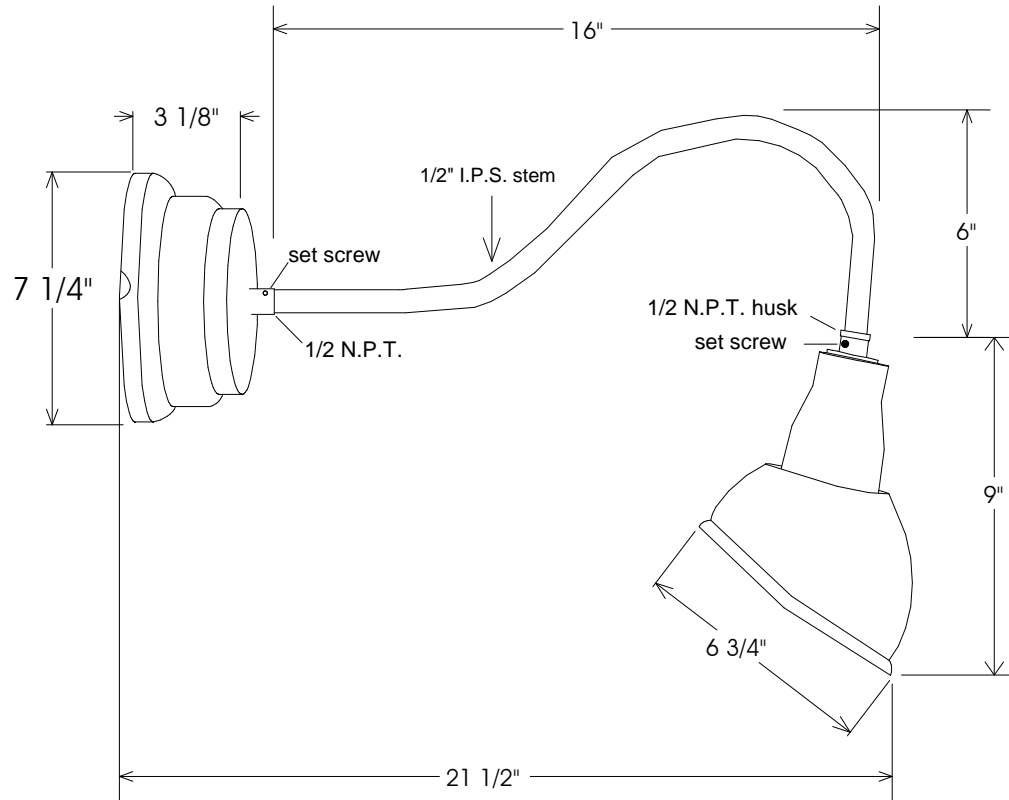
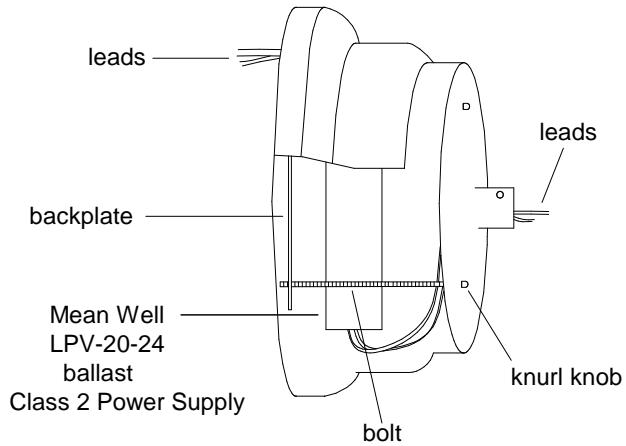

15A Shade

- 50,000 hour life
- Average savings is \$39.42 per year as compared to a 75 Watt incandescent
- Savings of \$ 518.16 for the life of the fixture
- Lumen output is equal to a 75 Watt bulb.

Unless Otherwise Specified: Dimensions in Inches Tolerances: Fractional ± Angular: Mach ± Bend ± Two Place Decimal ± Three Place Decimal ±	Name T.A.R.	Date 02/07/12	Primelite Mfg. Corp. 15/859 LED 24 Watt 1000 Lumens @ 3000K 1250 Lumens @ 4000K 24 Volt Output		
	Drawn				
	Checked				
	ENG Appr.				
	MFR Appr.				
Construction: All Aluminum	Comments CAD Generated Drawing Do Not Manually Update		Size A	Drawing No. 0001	Rev A
Pipe Size: 1/2"			Scale	CAD File	Sheet 1 of 1